

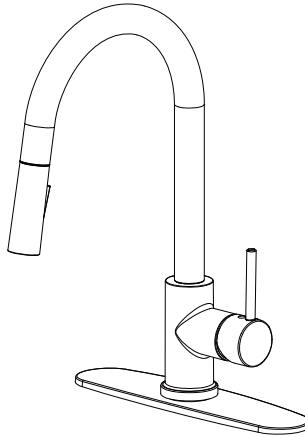

ALLORAUSA

INSTALLATION GUIDE



Single Handle Pull-Down Kitchen Faucet

A-805

TOOLS YOU WILL NEED



Adjustable Wrench



Pipe Tape



Phillips Screwdriver



Silicone Sealant

INSTALLATION TIPS

- Allora USA suggests using a locally licensed plumber for installation.
- Check if all the parts are present before beginning the installation.
- Cover your drain during the installation to avoid losing parts.

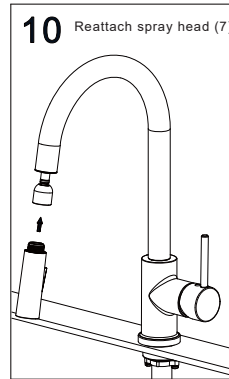
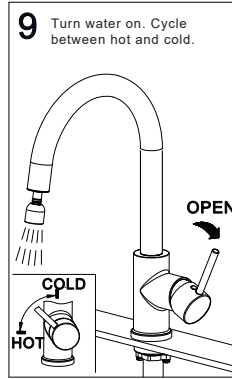
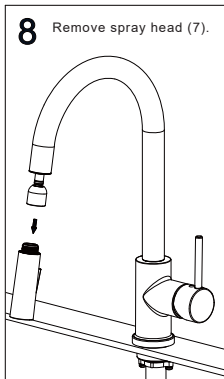
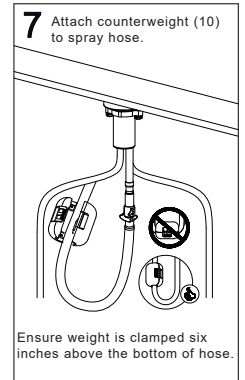
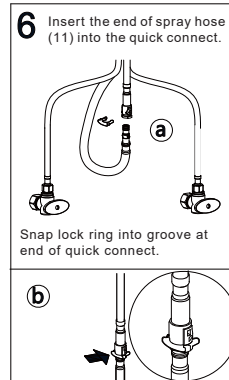
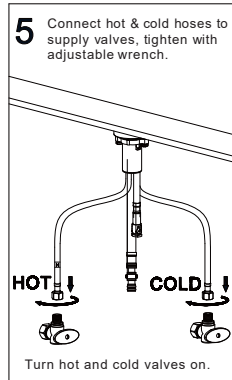
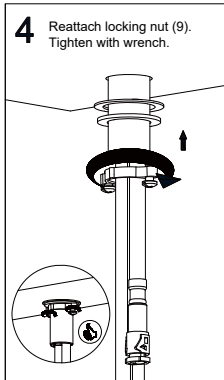
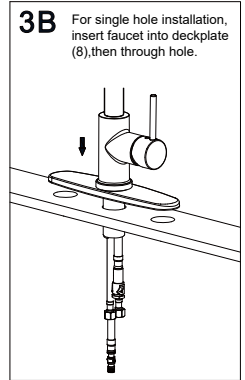
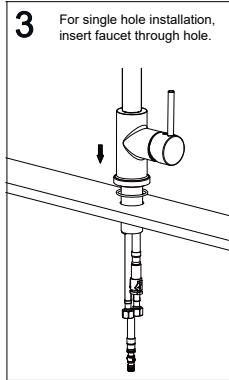
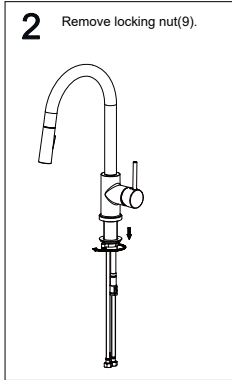
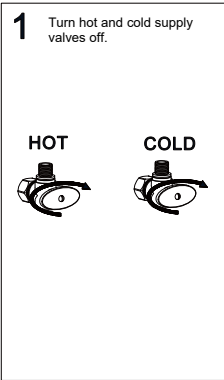

TROUBLESHOOTING

If you've followed the instructions carefully and your faucet still does not work properly, take these corrective steps.

PROBLEM	CAUSE	ACTION
Leaks underneath handle.	Retainer nut has come loose. O-ring is dirty or damaged.	Tighten the retainer nut. Clean or replace O-ring. If necessary, replace cartridge.
Aerator leaks or has an inconsistent water flow pattern.	Aerator is dirty or misfitted.	Unscrew aerator, remove any debris, check seating of rubber seal then re-assemble aerator. If necessary, replace aerator.

Need help? For technical assistance or replacement parts, please contact Allora USA Customer Service and one of our representatives will be happy to assist you:

Call 571-291-3484 or email Customerservice@allorausea.com

CARE & MAINTENANCE

To keep the product clean & shining, follow the steps below:

1. Rinse with clean water & dry with a soft cloth
2. Do not clean with soaps, acid, polish, abrasives or harsh cleaners
3. Do not use cloth with a coarse surface
4. Unscrew the aerator and clean when necessary

No.	Description	Part No.
1	Hot/Cold Indicator	AL4-10
2	Metal Handle	
3	Trim Cap	
4	Cartridge Lock Nut	
5	Ceramic Disc Cartridge (35mm)	AL1-05
6	Hose Guide	
7	Spray Head	AL805
8	Deck Plate (Optional)	
9	Two-Screw Lock Nut	AL4-13
10	Counterweight	AL4-08
11	Spray Hose	AL2-03

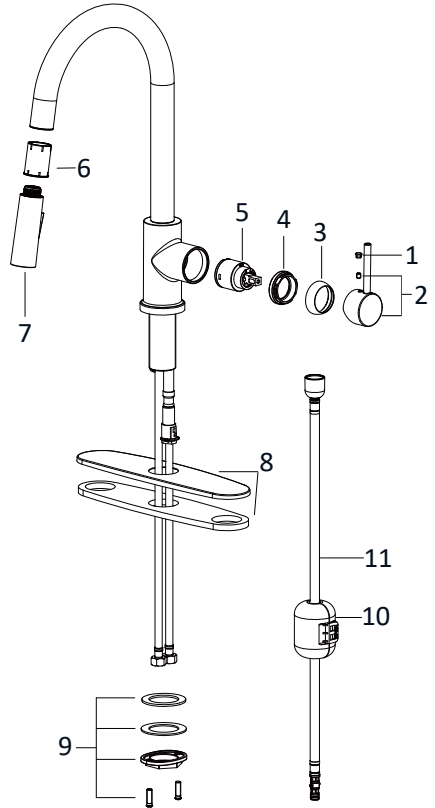

IMPORTANT

Register Your Allora USA Product

<http://www.allorausacom/registration>

Activate Your Warranty

Access Premium Customer Support

Get Product Information



REGISTER TODAY